

USB

0204

Audio Interface



Owner's Manual

 E-MU



**Owner's Manual**

© 2010 E-MU Systems  
All Rights Reserved

Revision: Revision A

**E-MU World Headquarters**  
**E-MU Systems**  
1500 Green Hills Road  
Scotts Valley, CA 95066  
USA

**Europe**  
**Creative Labs (Ireland) Ltd**  
Ballycoolin Business Park  
Blanchardstown, Dublin 15  
IRELAND

# TABLE OF CONTENTS

<b>Introduction</b> .....	<b>5</b>
<b>Package Includes</b> .....	<b>6</b>
<b>Computer Requirements</b> .....	<b>7</b>
Windows .....	7
OS X .....	7
<b>Software Installation</b> .....	<b>8</b>
Windows XP, Windows Vista or Windows 7 .....	8
Note About Windows Logo Testing .....	8
Uninstalling all Audio Drivers and Applications .....	8
Macintosh OS X .....	9
Uninstalling the Audio Drivers and Applications .....	11
<b>Connection Diagram</b> .....	<b>12</b>
<b>Controls &amp; Headphone Output</b> .....	<b>13</b>
<b>Input/Output</b> .....	<b>14</b>
<b>E-MU USB Audio Control Panel</b> .....	<b>15</b>
<b>Headphone Source</b> .....	<b>16</b>
<b>Direct Monitoring</b> .....	<b>17</b>
<b>Audio Recording Software</b> .....	<b>18</b>
<b>Troubleshooting</b> .....	<b>19</b>
<b>Internet References</b> .....	<b>20</b>
Forums .....	20
<b>Technical Specifications</b> .....	<b>21</b>
<b>Adapter Cables</b> .....	<b>23</b>
1/8" Headphone to 1/4" Headphone Adapter .....	23
Stereo Headphone to 2 x 1/4" Jack Splitter Cable .....	23
<b>Declaration of Conformity</b> .....	<b>24</b>
<b>0204 Block Diagram</b> .....	<b>26</b>
<b>Index</b> .....	<b>27</b>



## INTRODUCTION



Thanks for your purchase of the E-MU 0204 USB Audio/MIDI Interface. The 0204 provides 2 analog inputs, 4 analog outputs and brings an unparalleled level of USB audio quality to the Mac or PC, with pristine 24-bit/192kHz A/D and D/A converters, ultra-low jitter clock, and Class-A, ultra-low noise mic/line/hi-Z preamps. The signal-to-noise specs of the E-MU 0204 USB are unmatched by any other USB interface on the market! From its plug-and-play functionality and hands-on ergonomic design, to professional features like zero-latency direct monitoring, the USB will forever change your expectations of USB audio.

Some of the other key features are detailed below:

- Record and playback support for a multitude of sample rates: 44.1k, 48k, 88.2k, 96k, 176.4k, 192k (176.4k & 192k available on PC version only)
- Zero-latency direct hardware monitoring (disabled at 176.4k and 192k on the Macintosh)
- Full 24-bit resolution and stereo-in/stereo-out at all sample rates
- Independent ground lift switches for both analog inputs help to solve potential ground loop problems
- Headphone output can be used as separate stereo output from your software with analog volume control
- Studio-grade headphone amplifier
- Anti-pop speaker protection minimizes noise during power on/off
- Ultra-low jitter clock subsystem: <100ps RMS
- Windows drivers: ASIO2 and WDM
- Macintosh driver: Apple CoreAudio
- Kensington security lock

### NOTE

There are some limitations when operating at higher sample rates. See [page 15](#) for details.

## **PACKAGE INCLUDES**

- E-MU 0204 USB AudioPod
- USB cable
- 0204 USB installation guide

### **E-MU Software/Manual CD-ROM** (OS X /Windows)

- Windows XP, Windows Vista/x64, Windows 7/x64 drivers
- Mac OS X drivers
- Owner's manual and tutorials

### **Acoustica Mixcraft LE 4 Install CD-ROM** (Windows)

- Acoustica Mixcraft LE (multitrack recording application)

## COMPUTER REQUIREMENTS

The recommended computer system requirements for the E-MU 0204 USB are listed below.

### Windows

- Intel® Pentium® or AMD® processor – 1.2 GHz or faster
- Intel, AMD, or 100% compatible motherboard & chipset
- Microsoft® Windows® XP (SP3 or greater), Vista/x64, Windows 7/x64 Drivers
- 1 available (Hi-Speed) USB 2.0 port
- 1GB System RAM
- 950 MB of free hard disk space for full installation
- CD-ROM/CD-RW or DVD-ROM drive required for software installation
- XVGA Video (1024 x 768)

### OS X

- Apple® Macintosh® Intel-based processor – 1.2 GHz or faster  
*NOTE: For more information on Intel Mac support see the included ReadMe file, and/or [www.emu.com](http://www.emu.com) for latest information.*
- Apple Macintosh OS X, 10.5 or greater
- 1 Available (Hi-Speed) USB 2.0 port
- 1GB System RAM
- 500MB of free hard disk space for full installation
- CD-ROM/CD-RW or DVD-ROM drive required for software installation
- XVGA Video (1024 X 768)

## SOFTWARE INSTALLATION

### Windows XP, Windows Vista or Windows 7

Follow these instructions to install the 0204 USB software on a Windows computer.

1. First connect the 0204 USB to your computer using the supplied USB cable, and turn it on.
2. If Windows prompts you with an Add New Hardware Wizard, click **Cancel**.
3. Insert the E-MU software Installation CD into your CD-ROM drive. If Windows AutoPlay mode is enabled for your CD-ROM drive, the CD starts running automatically. If not, from your Windows desktop, click **Start->Run** and type **d:\setup.exe** (replace **d:\** with the drive letter of your CD-ROM drive). You can also simply open the CD and double-click **Setup.exe**.
4. The installation splash screen appears. Follow the instructions on the screen to complete the installation.
5. Choose "Continue Anyway" when you encounter the "Windows Logo Testing" warning screen. See the note below.
6. When prompted, restart your computer.
7. Be sure to register your 0204 USB so we can advise you of future software updates and special offers. You can register online at: [www.emu.com/register](http://www.emu.com/register)
8. Your 0204 USB is now ready to use.
9. Insert the **Acoustica Mixcraft LE 4 Install** CD-ROM into your CD-ROM drive.
10. The installation splash screen appears. Follow the instructions on the screen to complete the installation.

#### Note About Windows Logo Testing

When you install the 0204 USB drivers, you will see a dialog box informing you either that the driver has not been certified by Windows Hardware Quality Labs (WHQL), or that the driver is signed by Creative Labs, Inc., and you will be asked if you would like to continue with the installation.

The 0204 USB audio drivers are not certified by WHQL because the product does not support some of the features that the Microsoft Windows Logo Program requires, most notably Universal Audio Architecture (UAA) and Digital Rights Management (DRM).

Despite this, the 0204 USB audio drivers have been rigorously tested using the same test procedures that a WHQL qualified driver requires, and it passes in all of the other important categories, including those that measure the relative stability of the driver. So, it is perfectly safe to install these drivers on your computer.

#### Uninstalling all Audio Drivers and Applications

At times you may need to uninstall or reinstall the 0204 USB application and device drivers to correct problems, change configurations, or upgrade outdated drivers or applications. Before you begin, close the E-MU USB 2.0 Audio control application. Applications running during the uninstallation will not be removed.

1. Click **Start -> Control Panel**.
2. Double-click the **Add/Remove Programs** icon.
3. Click the **Install/Uninstall** tab (or **Change or Remove Programs** button).
4. Select the **E-MU 0204 USB** entry and then click the **Change/Remove** button.
5. In the **InstallShield Wizard** dialog box, select the **Remove ALL** option.



6. Click the **Yes** button.
7. Restart your computer when prompted.

You may now re-install existing or updated E-MU device drivers or applications.

## Macintosh OS X

Follow these instructions to install the 0204 USB drivers and software on a Macintosh OS X computer. First, connect the 0204 USB to your computer as shown on [page 12](#).

Install the 0204 USB Software

1. Insert the **E-MU Software/Manual CD-ROM** into your CD-ROM drive.
2. Double-click on the **E-MU** icon on the desktop.



3. Double-click on the **Install** icon to start the installation.



4. The installation Welcome screen appears. Follow the instructions on the screen.
5. When the **Authenticate** dialog box appears, enter the administrator password you chose when you installed OS X.
6. Continue to follow the instructions on the screen to continue the installation. You will be given the option to install:
  - **Easy Install:** Installs the following applications and drivers.  
E-MU 0204 USB: USB Drivers and Control Application
  - **Custom Install:** allows you to choose which components are installed.
7. **Easy Install** is recommended. The software will be quickly installed. When prompted, restart your computer.
8. Be sure to register your 0204 USB so we can advise you of future software updates and special offers. You can register online at: [www.emu.com/register](http://www.emu.com/register)

Set-up the 0204 USB as your Default Audio Device

9. Click **Go** -> **Utilities** from the menu bar.
10. Double-click **Audio MIDI Setup**, then click the **Audio Devices** button if it's not already selected. The window shown on the following page appears.
11. Select the 0204 USB for the following: **Default Input, Default Output, System Output, Properties For.**
12. Play a song on **iTunes** to verify that the 0204 USB is the default device for audio playback.
13. Quit iTunes.

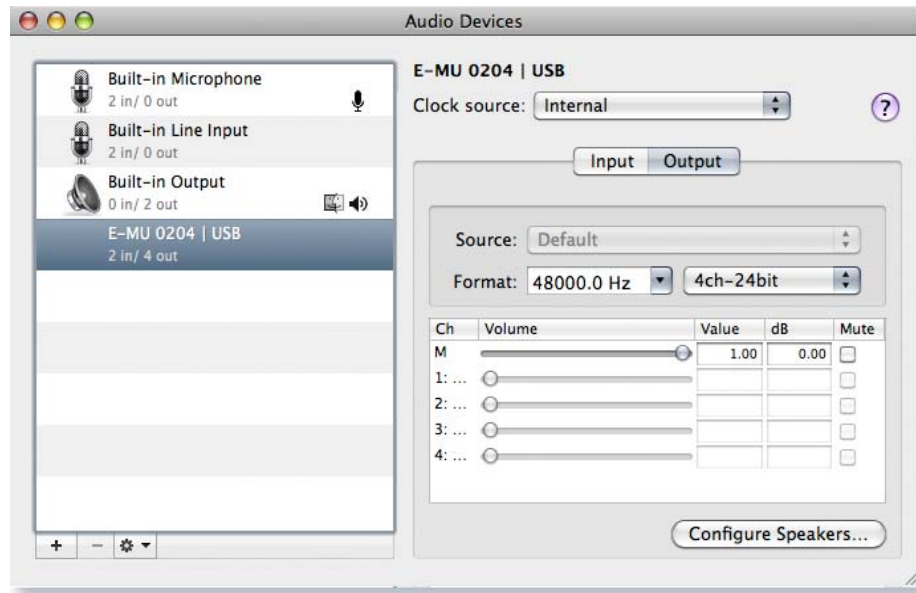



Setup the MIDI Devices

**NOTE:** If you already have a MIDI Interface connected, you can skip steps 14-19.

If you plan to use a MIDI keyboard, now would be a good time to set up your MIDI devices. Connecting a MIDI keyboard will allow you to use the virtual instruments provided in the software bundle and get the most out of your purchase. You'll also need a MIDI interface such as the E-MU Xmidi 2x2 or Xmidi 1x1.

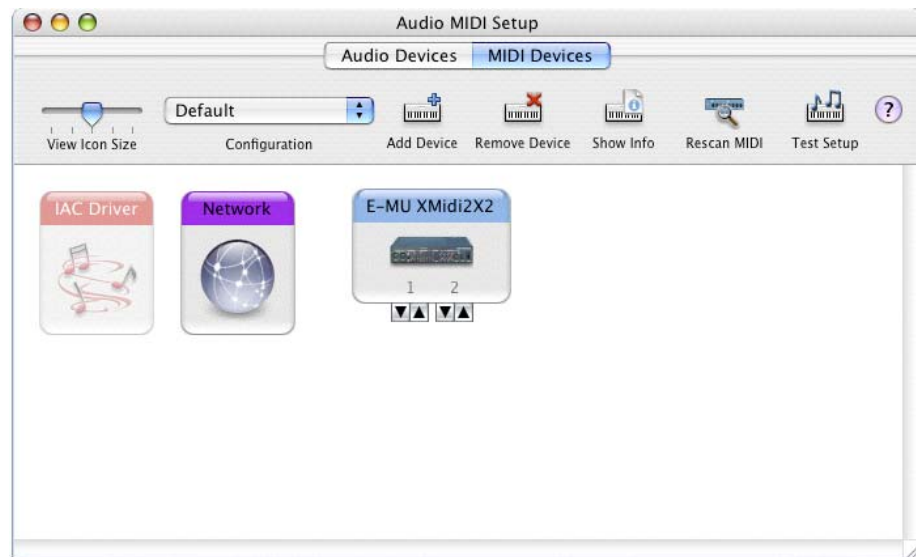
14. Click the **MIDI Devices** button. The window shown below appears.



15. Click the **Add Device** button. A new external device icon like the one shown at right appears.
16. Double-click on the new external device if you want to set the MIDI Keyboard Properties. You have the option to name and change the icon for the device. Click **Apply**, then click the **Close** button  to close the Properties window.



17. Connect the new external device to the E-MU 0204|USB by dragging between the input and output connectors.
18. The window below shows a properly connected MIDI device.

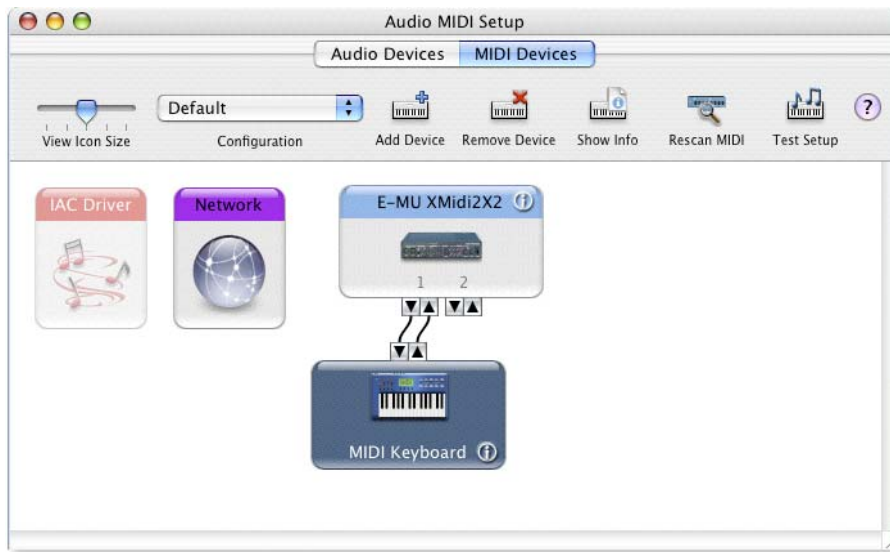

19. Press the close button  to close the Audio MIDI Setup window.

### **Uninstalling the Audio Drivers and Applications**

At times you may need to uninstall or reinstall the 0204 USB application and device drivers to correct problems, change configurations, or upgrade outdated drivers or applications. Before you begin, close the E-MU USB 2.0 Audio control panel application. Applications running during the uninstallation will not be removed.

1. Open the **Applications** folder.
2. Open the **Creative Professional** folder.
3. Open the **E-MU USB Audio** folder.
4. Click the **E-MU USB Audio Uninstaller** and follow the instructions.

## CONNECTION DIAGRAM

**WARNING!**

Use only a USB 2.0 certified Hi-Speed cable (like the one supplied) for the USB connection. Using a USB 1.1 cable may cause erratic behavior and degraded performance.

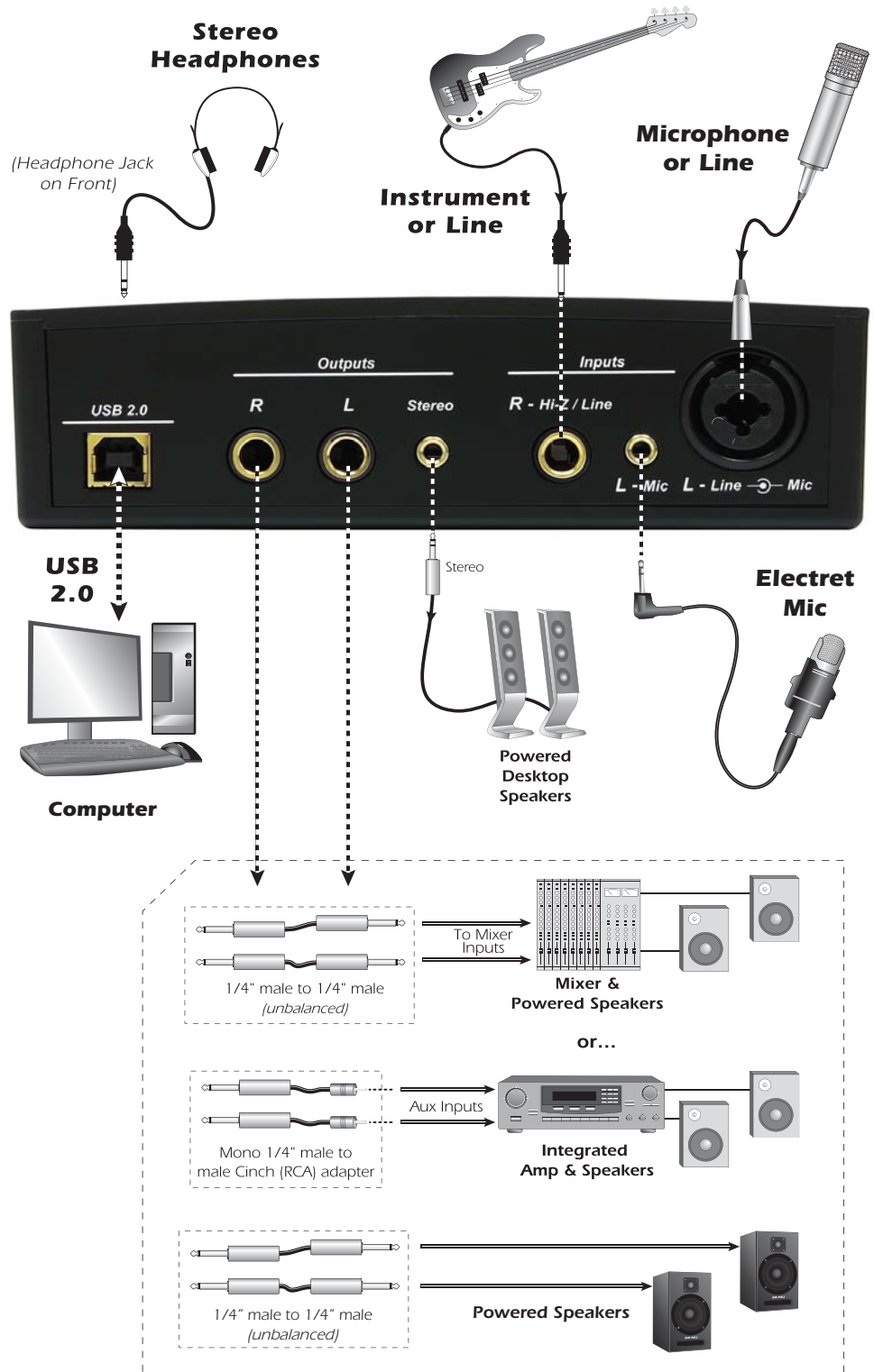

## CONTROLS & HEADPHONE OUTPUT



### 1. Signal Level & Clip Indicators

The LED signal level indicators make it easy for you to set a proper signal level. When the input level is too low, the green and red LEDs will both be off. When the input level is correctly set, the green signal LED should be flickering. If the signal level is too high, the green and red LEDs will both be on. The red clip indicators show that the input level has exceeded 0dBFS.

### 2. Left/Right Gain Controls

These controls set the input gain from 0dB to +60dB for the two inputs.

### 3. Direct Monitor Level Control

This digital encoder controls how much of the input signal is mixed with the signal from the computer and is adjustable from unity gain (no attenuation) to off. This feature allows you to hear your instrument through the monitor speakers while you are recording. The Direct Monitor Control does not have end-stops like the other controls and you may have to turn it more than one revolution to set the desired level.

### 4. Direct Monitor On/Off & Mono-Stereo Switch

Press the button to turn Direct Monitoring on and off and to switch modes. The stereo LED illuminates. The left and right channels are passed through to their respective outputs at the level set by the Direct Monitor Level control. Press the button again to sum the left and right direct monitor channels to mono. Mono mode is useful when the two inputs are being used for separate instruments. See [“Direct Monitoring” on page 17](#).

### 5. Headphone Jack

This is a 1/4" jack to connect your stereo headphones. If your headphones use the smaller 1/8" plug, you'll need an adapter of the type shown on [page 23](#).

The stereo headphone channels can be configured to be independent of the main outputs. This allows you to create a separate headphone mix in your recording application or use the headphone jack as another pair of outputs. See [page 23](#) for an illustration of a headphone adapter cable.

### 6. Headphone Level Control / Power Switch

This knob controls the volume of the headphone output. This switch also turns the 0204 USB on or off.

### 7. Kensington Security Lock

## INPUT/OUTPUT

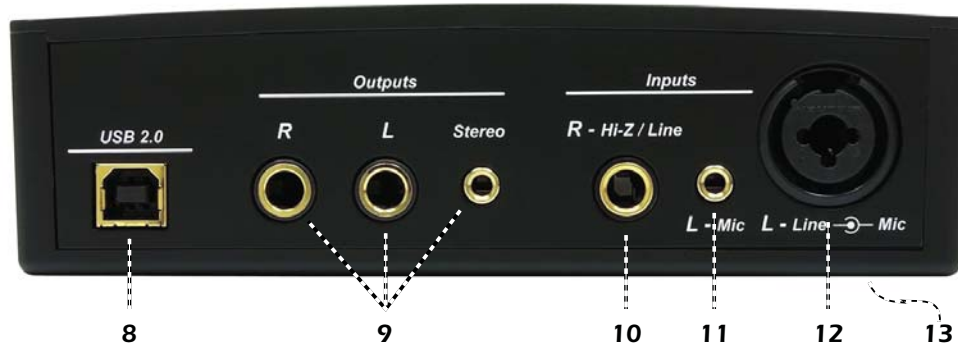

### 8. USB

Connects the 0204 USB to your computer via the supplied USB cable. The USB connection provides two-way communication when connected to the computer.

The 0204 USB receives its power from the USB. Always connect to the USB jack on the computer itself and NOT to a low-power USB connection that may be present on your computer keyboard or other USB peripheral.

### 9. Main Outputs

The unbalanced outputs are normally connected to your monitoring system. The signal is duplicated on a stereo 1/8" jack for easy connection to desktop stereo speakers. The outputs have been designed using a special noise-cancelling circuit which reduces problems relating to ground loops.

The main output volume can be controlled using the System Volume Control on your Mac or PC (WDM only on PC).

#### System Volume Control

Mac 

PC 

### 10. R - Hi Z / Line Input

This 1/4" input can be used as a Hi-Z instrument input (guitar/bass, etc.) or a line level input. The input is balanced, but accepts either balanced or unbalanced signals.

### 11. L - 1/8" Mic Input

This 1/8" mini-phone jack is designed to accept an electret condenser microphone. The jack supplies +5VDC phantom power required by electret mics.

### 12. L - Hi-Z / Line / Mic Input

Use the XLR connector for microphones or balanced line level signals. Use the 1/4" in the center of the XLR jack as a Hi-Z input for guitar/bass, or as a line level input. The input is balanced, but accepts either balanced or unbalanced signals.

### 13. Ground Lift Switches

The "ground lift" switches, located on the bottom of the unit, can be used to safely stop the hum if a ground loop occurs in your setup. See [page 19](#) for more information.

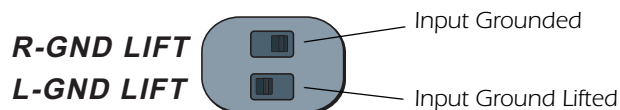

The input ground is lifted when the A or B slide switch is closest to the GND LIFT label.

## E-MU USB AUDIO CONTROL PANEL

After you have successfully installed the audio drivers, launch the E-MU USB Audio control panel. The E-MU USB Audio Control Panel is shown below.

- **Windows:** The E-MU USB Audio control icon will be visible in the Taskbar, which is normally located in the bottom right of the screen. It can also be launched from the Start Menu (*All Programs, Creative Professional, E-MU USB Audio Application*).
- **OS X** The E-MU USB Audio control application is located in the **Applications** folder . You can also open the application using the icon on the desktop.

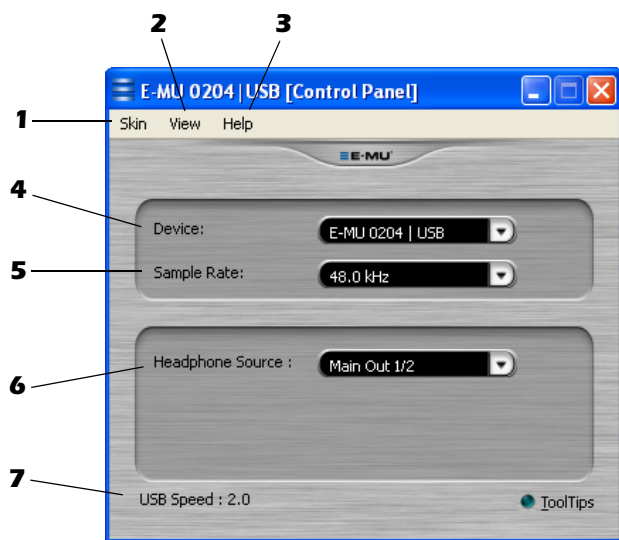

### 1. Skin

Choose between several different appearances for the control panel.

### 2. View

Hide the application (Ctrl+H, Windows). You can restore the application by clicking the E-MU icon  in the System Tray (Windows), or by clicking the E-MU icon in the Dock (OS X).

### 3. Help

About E-MU 0204 USB, Audio control, Launch Manual, Check Updates.

### 4. Device

If you are using more than one E-MU USB Audio device, you can choose which unit is currently being controlled.

### 5. Sample Rate

Allows you to set the system sample rate: 44.1, 48, 88.2, 96, 176.4 or 192 kHz.

### 6. Headphone Source

The Headphone Source controls whether the headphone output monitors the **MainOut 1/2** or receives its signal from **Aux 3/4** of your software application. The default setting is Main Out 1/2 (*Headphones monitor main outputs*). Refer to the following page for more information about this control.

### 7. USB Speed

Indicates if you are connected to a USB 1.1 or USB 2.0 port on your computer.

#### NOTE

Macintosh operation up to 96kHz only at this time – check [www.emu.com](http://www.emu.com) for updates

## HEADPHONE SOURCE

The stereo headphone output can either duplicate the main outputs, or it can be used as another completely independent pair of outputs when using ASIO. This setting is controlled from the 0204 Control Panel. The headphone output is a high-quality signal, with increased power for driving headphones.

With the Headphone Source set to Main Out 1/2, the headphone output duplicates the signal on the main outputs. With the Headphone Source set to Aux 3/4, the headphone output receives its signal from outputs 3/4 of your software application.

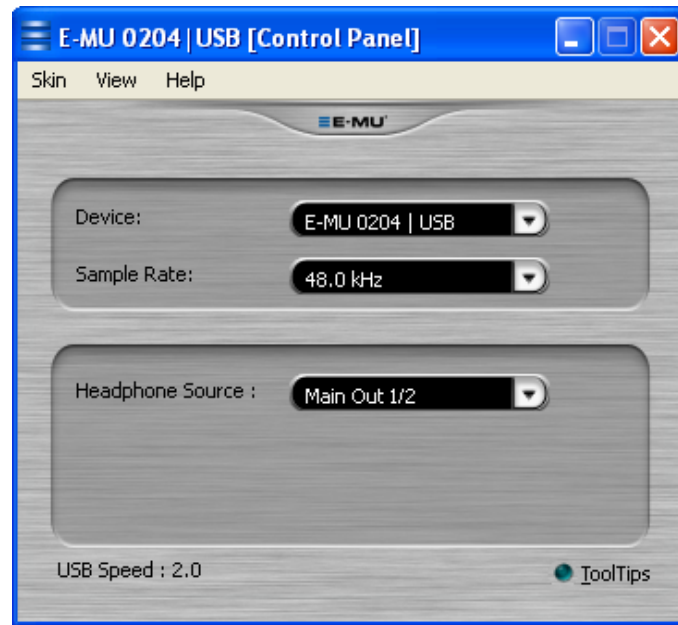

### Headphones Duplicate Main Outputs (Headphone Source = Main Out 1/2)

This is the setting you'll normally want if you're only using one pair of outputs, such as stereo recording/playback or listening to music. This is the default setting.

### Separate Headphone Mix

By selecting Headphone Source Aux 3/4, you can create a separate headphone mix for live performance or while recording.

### Two Additional Outputs

With an appropriate cable adapter (see [page 23](#)), the headphone output becomes another pair of signal outputs (3/4). The headphone signal is of the same exceptional quality as the main outputs with the addition of an analog volume control.

**Note:** At the highest sample rates (176.4/192 kHz), the Headphone Source feature is disabled. In this case, the headphone output duplicates the main outputs.

The Headphone Source feature is also disabled when using WDM on a Windows computer. In this case, setting the Headphone Source to Aux 3/4 will turn off the headphone output.



## DIRECT MONITORING

Direct monitoring allows you to monitor inputs without having any software open. It can also be used as an alternative to software monitoring if you desire the lowest latency monitoring possible.

When using a computer for digital recording, an audible time delay occurs while the audio signal is being input to the computer, processed by the software and then returned to the output for monitoring. This time delay is called *Latency*.

Latency becomes a problem when you have to use high buffer settings to conserve CPU resources. Because the 0204 USB has hardware direct monitoring, you can enjoy zero latency regardless of your buffer setting.

The Direct Monitor feature connects the input signals to the output when recording so that you can hear your performance without delay. The Direct Monitor level control lets you adjust the volume of the input signal in relation to the recorded tracks.

Direct monitoring is controlled manually from the Direct Monitor switch on the 0204 USB. It's not necessary to turn it on in your recording application.

### NOTE

Direct monitoring on channels 1/2 only at 176.4 or 192 kHz sample rates.

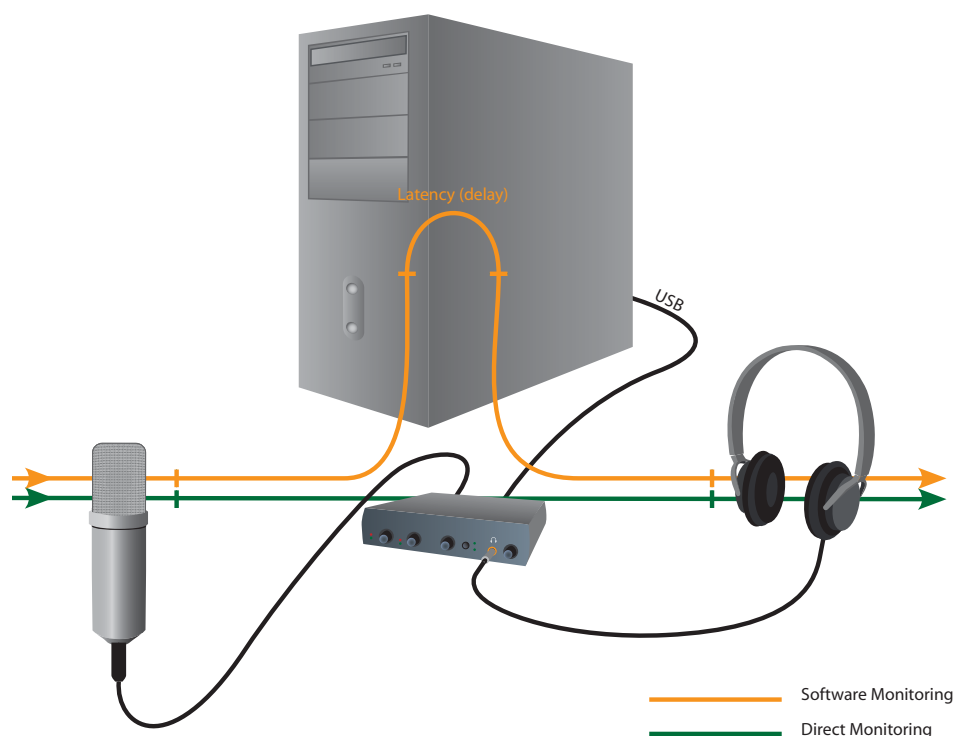

Direct Monitoring allows you to listen to the **direct** sound of your instrument during recording, without the delay incurred by going to the computer and back.

### Direct Monitoring vs. Software Monitoring

Direct monitoring is lower latency and can also be used without software running.

Software monitoring has the advantage of allowing audio effects or EQ added in the host software to be heard on the output. Its round-trip latency depends on what latency is chosen in the ASIO configuration. If you choose to software monitor, make sure to disable direct monitoring. If both are enabled, you will experience a 'comb filter' or doubling effect.

## AUDIO RECORDING SOFTWARE

Now that you've installed the 0204 USB, you probably want to start using it! The 0204 USB is only one half of the equation—the hardware interface that translates audio signals into the digital language of your computer. The second half of the equation is the software recording application, which records and allows you to edit the audio on your computer.

### Acoustica Mixcraft LE 4™

We have included Acoustica Mixcraft LE 4 for PC users. Acoustica Mixcraft LE 4 is a full-featured multitrack recording application with effects, virtual instruments, VST™ and DirectX™ support and much more.

Tutorials and Videos: <http://www.acoustica.com/mixcraft/support.htm>

### Macintosh Users

Unfortunately we were not able to include a Macintosh recording application with the 0204 USB, however you can use Garage Band, a very cool music application that probably came bundled with your Mac. This application works well with the 0204 USB and will get you started with audio recording.

### NEED MORE HELP?

If you need additional help, please see:

- **Windows:** Program Files\Creative Professional\E-MU 0204 USB\Documents\3rdParty.htm
- **OS X:** Applications Drive\Library\Documentation\E-MU 0204 USB\3rdParty.htm

### Before you Begin...

- You should have already installed the E-MU software on your computer
- You should hear the computer sounds coming out of the E-MU 0204 USB and your speakers when you play a CD or an MP3 using Windows Media Player or iTunes. If not, make sure your E-MU 0204 USB is properly connected according to the diagram on [page 12](#).
- A source of audio should be connected to the inputs (a microphone, musical instrument, or CD/MP3 player).

### WARNING!

Windows Users - After checking your audio, be sure to quit Windows Media Player.

## TROUBLESHOOTING

### Can't hear Windows Media Player in Windows

If you have, or ever have had, another audio device installed in your PC, you may have to set the E-MU 0204 USB as the "Default Audio Device".

1. Open the **Control Panel**, then select **Sounds and Audio Devices**.
2. Click the **Audio** tab and select the **E-MU 0204 USB** as the Default device under **Sound Playback**.
3. Click the **Volume** button under Sound Playback and turn up **Wave volume**.

You cannot record or monitor ASIO and WAVE at the same time. The first audio application you open controls the E-MU 0204 USB.

### Lost Communication

Should you lose communication between your E-MU 0204 and an audio application (Ableton Live, Cubase, Sonar, etc.), the E-MU 0204 USB drivers may need to be re-selected in your application.

1. Go to your application's I/O settings, de-select the **E-MU 0204 USB** for both input and output.
2. Apply these changes and exit the dialog.
3. Re-enter the application's preference settings and re-select the **E-MU 0204 USB** drivers. If this doesn't work, the application may need to be restarted.

### Ground Loops

In digital audio devices and computers, audio ground loops may appear as pitched tones, digital hash in the background, as well as the familiar 50/60 cycle hum.

Ground loops are caused by a difference in ground potential between two pieces of equipment. Computer audio devices are particularly susceptible to ground loops because most computers were not designed with high quality audio in mind.

The E-MU 0204 USB contains built-in "ground lift" switches for both analog inputs in order to safely break the loop if a ground loop occurs in your setup.

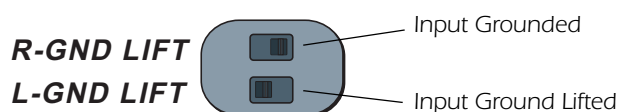

The ground-lift switches are located on the bottom of the unit, close to the rear panel. The input ground is lifted when the A or B slide switch is closest to the GND LIFT label.

### Pops & Crackles

Pops and crackling noises in the audio are most often caused by having the *ASIO Buffer Size* set too low. Adding audio tracks and VST plug-ins increases the load on your computer's CPU. If your computer cannot keep up with all the tasks you are asking it to perform, pops and crackles may occur. In effect, increasing the ASIO buffer gives your computer "more time" to complete its assigned tasks. The hardware Direct Monitor feature of the 0204 USB allows you to increase the ASIO Buffer setting without the associated latency problems during recording and overdubbing.

*USB hubs* can create problems with digital audio and should be avoided whenever possible.

**Simultaneous WDM/ASIO Playback (PC only)**

The 0204 USB only supports playing back one stream format at a time on the PC. Each of the two mentioned stream types has an associated priority. If a higher priority stream type is opened while a lower priority stream is already playing, the lower priority stream will stop playing. The stream priorities, from highest to lowest, are ASIO, WDM.

**Headphone Source using WDM (PC only)**

The Headphone Source feature only functions using ASIO at this time. The Headphone output will be disabled if the Headphone Source in the 0204 USB Control Panel is set to Aux 3/4.

**USB 1.1 vs USB 2.0 Ports**

The 0204 requires a USB 2.0 port for error-free audio performance. The E-MU USB Audio Control panel indicates if you are connected to a USB 1.1 or USB 2.0 port on your computer.

**0204 USB comes up in USB 1.1 mode (PC only)**

Always turn the 0204 USB power off before connecting or disconnecting the USB cable. Hot-plugging the unit with the power on can cause the 0204 to power-up in USB 1.1 mode. If you see the Windows message, "This device could perform faster...", simply turn power off, wait a few seconds, then turn power on again.

**INTERNET REFERENCES**

The internet contains vast resources for the computer musician. A few useful sites are listed here, but there are plenty more. Check it out.

- Software Updates, Tips & Tutorials . <http://www.emu.com/support>
- Setting up a PC for Digital Audio .... <http://www.musicxp.net>
- MIDI Basics..... Search for "MIDI Basics" (many sites)
- MIDI & Audio Recording..... <http://www.midiworld.com>
- MIDI & Audio Recording..... <http://www.synthzone.com>
- Mixcraft ..... <http://www.acoustica.com/mixcraft/index.htm>

**Forums**

- Unofficial E-MU Forum..... <http://www.productionforums.com/emu>
- Sound-On-Sound Forum ..... <http://www.soundonsound.com>
- Computer Music Forum ..... <http://www.musicradar.com/computermusic>
- Home Recording Forum..... <http://homerecording.com/bbs>
- Studio Central Forum..... <http://www.tweakheadz.com>
- KVR Forum ..... <http://www.kvraudio.com/forum>
- Sound Card Benchmarking..... <http://audio.rightmark.org>
- Driver Heaven Forum ..... <http://www.driverheaven.net>

## TECHNICAL SPECIFICATIONS

### General

- Sample Rates: 44.1, 48, 88.2, 96, 176.4, 192kHz from internal crystal with no sample rate conversion \*
- Bit Depth: 24-bit I/O, 32-bit processing
- USB 2.0 Hi-Speed
  - Full 24-bit resolution at all sample rates
  - 2 in/4 out channels
- Zero-latency direct hardware monitoring  
(Direct monitor on channels 1/2 only at 176.4/192kHz sample rates)
- Windows drivers: ASIO2 and WDM
- Macintosh driver: Apple CoreAudio
- Anti-Pop speaker protection minimizes noise during power on/off
- Ultra-low jitter clock subsystem: <100ps RMS

### Combo Preamplifiers

- Type:
  - (1) Ultra-low noise combo preamplifier with Mic/ Hi-Z/line inputs
  - (1) Combo preamplifier with Hi-Z/ balanced input
  - (1) 1/8" condenser mic input with 5V power
- A/D Converter: AK5385
- Max. Level: +6.5dBV (+8.7dBu)
- Input Impedance: 1.5 kOhms
- Frequency Response (min gain, 20Hz-20kHz): +0.0/-0.07dB
- Dynamic Range (A-weighted, 1kHz, min. gain): 113dB
- Signal-to-Noise Ratio (A-weighted, min. gain): 113dB
- THD+N (1kHz at -1dBFS, min. gain): -101.9dB (.0008%)
- Ultra-low noise preamplifier (Mic/Hi-Z/line inputs)
  - Input Impedance: 1.5Kohm
  - EIN (20Hz-20kHz, 150ohm, unweighted): -127dBu
- Combo preamplifier with Hi-Z/line balanced input - Input Impedance: 1Mohm

### Analog Line Outputs (2)

- Type: balanced, AC-coupled, 2-pole low-pass differential filter
- D/A converter: AK4396
- Max Level: 6.7 dBV (unbalanced)
- Frequency Response (20Hz - 20kHz): 0.00/-0.01dB
- Dynamic Range (1kHz, A-weighted): 117dB
- Signal-to-Noise Ratio (A-weighted): 117dB
- THD+N (1kHz at -1dBFS): -101.9dB (.0008%)
- Stereo Crosstalk (1kHz at -1dBFS): -111dB

### **Headphone Amplifier**

- Type: Class-A power amplifier
- D/A converter: AK4396
- Gain Range: 60dB
- Maximum Output Power: 16mW
- Output impedance: 22ohms
- Frequency Response (20Hz-20kHz): +0.02/-0.08dB
- Dynamic Range (A-weighted): 117dB
- Signal-to-Noise Ratio (A-weighted): 117dB
- THD+N (1kHz, max gain): 300ohm load: -101.9dB (.0008%)
- Stereo Crosstalk (1kHz at -1dBFS, 300 ohm load): -107dB

### **Synchronization**

- Internal crystal sync at 44.1, 48, 88.2, 96, 176.4, 192kHz\*

### **Dimensions/Weight:**

- Weight: 0.94 lb / 0.43 kg
- Dimensions:  
    W: 6.5"      H: 2.0"      L: 5.5"  
    W: 165 mm   H: 50.8 mm   L: 140 mm

\* Macintosh operation up to 96kHz only at this time – check [www.emu.com](http://www.emu.com) for updates

## ADAPTER CABLES

### 1/8" Headphone to 1/4" Headphone Adapter

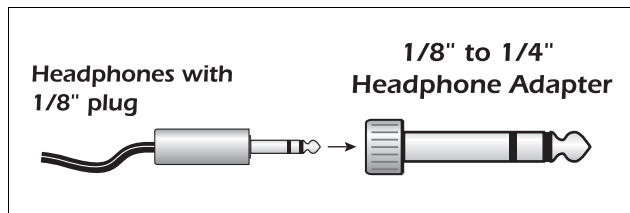

### Stereo Headphone to 2 x 1/4" Jack Splitter Cable

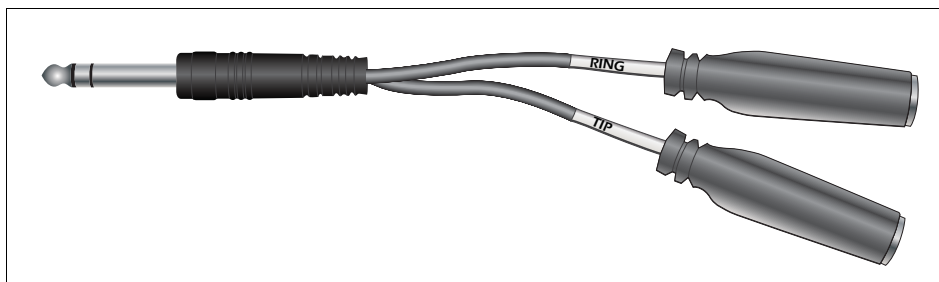

This type of adapter allows you to use the Headphone jack as another pair of line outputs. The tip and ring of the headphone plug are split off into separate outputs.

## **DECLARATION OF CONFORMITY**

**Trade Name:** E-MU Systems  
**Model No.:** EM8740A  
**Responsible Party:** E-MU Systems  
**Address:** 1500 Green Hills Road  
Scotts Valley, CA 95066 U.S.A.

This device complies with Part 15 of the FCC rules. Operation is subject to the following two conditions: (1) This device may not cause harmful interference, and (2) this device must accept any interference received, including interference that may cause undesired operation.

### **CAUTION**

You are cautioned that any changes or modifications not expressly approved in this manual could void your authority to operate this equipment.

### **Note:**

This equipment has been tested and found to comply with the limits for a Class B digital device, pursuant to Part 15 of the FCC Rules. These limits are designed to provide reasonable protection against harmful interference in a residential installation. This equipment generates, uses, and can radiate radio frequency energy and, if not installed and used in accordance with the instructions, may cause harmful interference to radio communications. However, there is no guarantee that interference to radio or television reception, which can be determined by turning the equipment off and on, the user is encouraged to try to correct the interference by one or more of the following measures:

- Reorient or relocate the receiving antenna.
- Increase the separation between the equipment and receiver.
- Connect the equipment into an outlet on a circuit different from that to which the receiver is connected.
- Consult the dealer or an experienced radio/TV technician for help.

The supplied interface cables must be used with the equipment in order to comply with the limits for a digital device pursuant to Subpart B of Part 15 of FCC Rules.



## **Compliance Information**

### **United States Compliance Information**

FCC Part 15 Subpart B Class B using:

CISPR 22 (1997) Class B

ANSI C63.4 (2003) method

FCC Site No. 958979

### **Canada Compliance Information**

ICES-0003 Class B using:

CISPR 22 (1997) Class B

ANSI C63.4 (2003) method

Industry of Canada File No. IC 5933

### **European Union Compliance Information**

EN55024 (1998 w/A1:01 & A2:03)

EN55022 (1998) Class B

### **Australia/New Zealand Compliance Information**

AS/NZS CISPR 22 (2002) Class B using:

EN55022 (1998) Class B

### **Japan Compliance Information**

VCCI (April 2005) Class B using:

CISPR 22 (1997) Class B

ANSI C63.4 (2003) method

VCCI Acceptance Nos. R-2160 & C-2332

### **Attention for the Customers in Europe**

This product has been tested and found compliant with the limits set out in the EMC Directive for using connection cables shorter than 3 meters (9.8 feet).

### **Notice**

If static electricity or electromagnetism causes data transfer to discontinue midway (fail), restart the application or disconnect and connect the USB cable again.

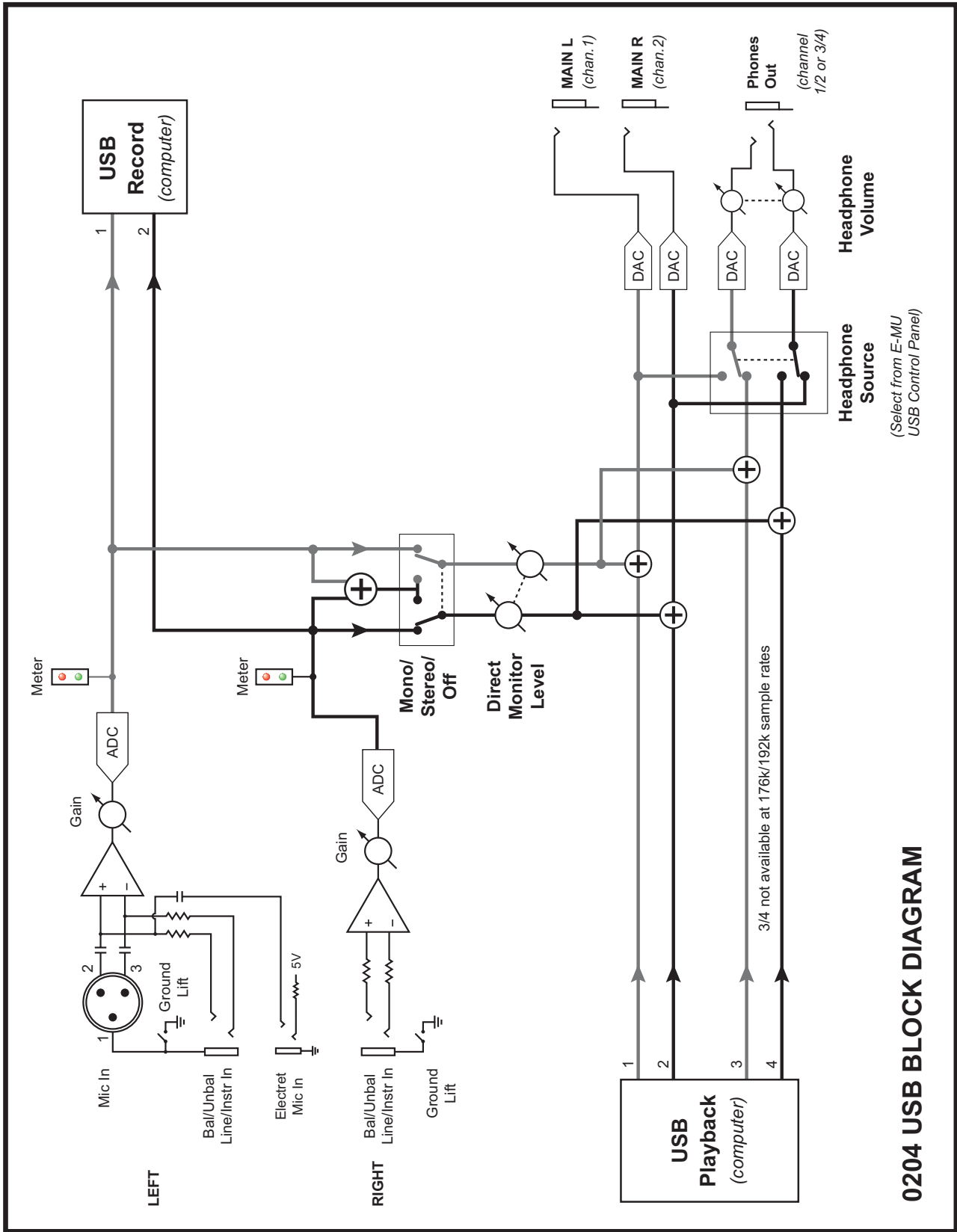

## INDEX

### A

Acoustica Mixcraft LE 4 18  
Adapter Cables 23  
ASIO Buffer Size 19

### B

Block Diagram 26

### C

Clip Indicators 13  
Computer Requirements 7  
Connection Diagram 12, 14  
Control Panel 15, 16

### D

Device Select, E-Control 15  
Direct Monitor Controls 13  
Direct Monitoring 17  
Direct Monitoring vs Software Monitoring 17

### E

E-Control Application 15

### G

Gain Controls 13  
Ground Lift Switches 14, 19  
Ground Loops 19

### H

Headphone Level Control 13  
Headphone Mix, creating 16  
Headphone Output 14  
Headphone Source 16  
Hi-Z Input 14

### I

Inputs 14  
Internet References 20

### L

Latency 17  
Lost Communication 19

### M

Main Output Volume Control 14  
Monitoring, direct vs software 17

### O

Output Volume Control 14  
Outputs 3/4 16

### P

Package Contents 8  
Pops & Crackles 19

### R

Recording Software 18

### S

Signal Level Indicators 13  
Signal Routing Diagram 26  
Simultaneous WDM/ASIO/AC-3 Playback 20  
Skin, selecting 15  
Software Installation  
    Mac OSX 9  
    Windows 8

### T

Technical Specifications 21, 23  
Testing Your Interface 18  
Troubleshooting 19

### U

Uninstalling Drivers & App 8, 11  
USB 1.1 Warning Message 20  
USB Jack 14

### V

Volume Control, controlling with computer 14

### W

WDM/ASIO/AC-3 Playback 20  
Windows Logo Testing Note 8  
Windows Media Player, no audio 19

